



Smart weather sensor
Installation and operating manual

Item no. 10771001



The Smart weather sensor can only be used unrestrictedly with a Premium gateway.

This manual.....	27
How to use this manual	27
Hazard symbols.....	27
Levels of danger and signal words.....	27
Symbols and depictions used.....	28
Safety instructions	29
Intended use.....	30
Improper use	30
Functional description.....	31
Important information prior to installation and commissioning.....	34
Installation of the Smart weather sensor	35
Safety instructions for the electrical connection	38
Electrical connection.....	39
Final installation of the Smart weather sensor.....	40
Important information for service personnel and fitters	41
Resetting the Smart weather sensor to the factory settings.....	42
Service / maintenance and care	43
Technical specifications of the Smart weather sensor.....	44
Simplified EU declaration of conformity.....	44
Factory settings of the Smart weather sensor.....	45
Factory settings for the integrated actuator	46
Rear wall view and drilling template	47

i This manual...

describe how to install, connect and operate the **Smart weather sensor**.

i How to use this manual

- ◆ Before you begin, please read this manual through completely and follow all the safety instructions.
- ◆ This manual is part of the product. Please store it in an easily accessible place.
- ◆ When passing the Smart weather sensor on to a third party, this manual must be passed on as well.
- ◆ Damage resulting from non-compliance with this manual and the safety instructions will void the warranty. We assume no liability for any consequential damage.

i Hazard symbols

The following hazard symbols are used in this manual:



Danger to life resulting from electric shock



Danger area / dangerous situation

i Levels of danger and signal words



This hazard will lead to serious injury or death if not avoided.



This hazard may lead to property damage.



Depiction	Description
-----------	-------------

1.	Procedures
----	------------

2.	
----	--

◆	Itemisation
---	-------------

1)	Lists
----	-------



Further useful information



Please read the respective manual.



Danger to life resulting from electric shock when working on all electrical systems.

- ◆ Installation, testing, commissioning and troubleshooting may only be carried out by an authorised qualified electrician.
- ◆ Carry out all installation and connection work only in a de-energised state.
- ◆ Observe the safety instructions for electrical connection on page 38.



The use of defective devices can lead to personal injury and damage to property (electric shock / short circuit).

- ◆ Never use defective or damaged devices.
- ◆ Check the Smart weather sensor for damage.
- ◆ Please contact our Customer Service department if you determine any damage, see page 48.
- ◆ If the Smart weather sensor is defective, ensure the awning system is disabled and secure it to prevent it being switched back on.
- ◆ Take due care while adjusting the awning and keep people away from the moving awning.



Please ensure that no-one is allowed to remain in the travel range of system parts driven by the motor (risk of crushing!). The corresponding building regulations must be observed.



Danger due to drives starting up during cleaning and maintenance

If cleaning or maintenance has to be carried out in the vicinity of the awning(s) or Venetian blind(s), the system must be isolated by switching off the site-provided fuse and secured to prevent it switching on again.



Intended use

EN

Use the Smart weather sensors solely for the control of DuoFern end units within a DuoFern network.

Use the integrated actuator solely for the connection of a tubular motor or awning motor.

Operating conditions

- ◆ A 230 V/50 Hz power supply, together with a site-provided isolating device (fuse), must be available for the electrical connection at the installation location.
- ◆ The awning mechanism must retract and extend easily.
- ◆ The installation and operation of radio systems is only permitted for systems and devices where a malfunction in the transmitter or receiver would not cause a danger to persons or property or where this risk is already covered by other safety equipment.



Radio systems which transmit on the same frequency can cause interference.



Improper use

Using the Smart weather sensor for any other purpose than previously mentioned is not permissible.



Improper use can lead to personal injury or property damage.

- ◆ Never use the existing radio system (e.g. DuoFern radio system) and its components for the remote control of appliances and systems with increased safety-relevant requirements or where there is an accident risk. Applications of this kind require additional safety equipment. Observe the respective statutory regulations for the installation of such systems.
- ◆ Please remember that the rails of sunshade installations installed on the outside of the building can freeze. If the awning or Venetian blind is then moved, the sun shading and drive may be damaged.

The Smart weather sensor captures **environmental parameters** and can therefore take over most of the automatic control within a DuoFern network.

The following environmental parameters are measured:

- ◆ Outdoor temperature (Can only be used in conjunction with Premium gateway!)
- ◆ Lighting
- ◆ Wind velocity
- ◆ Precipitation (rain)

Comparative table showing various light values

Ambient conditions	Light values
Bright summer day	70 kLux
Overcast summer day	20 kLux
Shade in the summer	10 kLux
Overcast winter day	3 kLux
Room lighting	800 Lux
Street lighting	10 Lux

Wind velocity in various units

Description	m/s	km/h	Wind strength (Beaufort)
Calm	< 0.3	< 1.1	0
Almost calm	0.3 - 1.5	1.1 - 5.4	1
Very slight wind	1.6 - 3.3	5.5 - 11.9	2
Light wind	3.4 - 5.4	12.0 - 19.4	3
Moderate wind	5.5 - 7.9	19.5 - 28.4	4
Fresh wind	8.0 - 10.7	28.5 - 38.5	5
Very fresh wind	10.8 - 13.8	38.6 - 49.7	6
Strong wind	13.9 - 17.1	49.8 - 61.5	7
Very strong wind	17.2 - 20.7	61.6 - 74.5	8
Stormy wind	20.8 - 24.4	74.6 - 87.8	9
Heavy storm	24.5 - 28.4	87.9 - 102.2	10
Hurricane-like storm	28.5 - 32.6	102.3 - 117.3	11
Hurricane	> 32.6	> 117.3	12

Integrated tubular motor actuator

In addition, the Smart weather sensor has an integrated tubular motor actuator.



Smart weather sensors and actuators work independently of each other, therefore the integrated actuator can be set and used like an external actuator.

The functions of the integrated tubular motor actuator

The Smart weather sensor is configured using the HOMEPILOT app. After the successful setting of the Smart weather sensor, the integrated tubular motor actuator can be set and controlled like any other DuoFern actuator.

Functions:

- ◆ Connection option for a tubular motor
- ◆ Random function
- ◆ End points adjustable by radio (only with HOMEPILOT tubular motors with electronic end point adjustment)
- ◆ Reversal of rotation direction
- ◆ Adjustable ventilation position
- ◆ Radio code
- ◆ Execution of manual switching commands (Up / Stop / Down) from a DuoFern transmitter, e.g. Smart remote control 6 groups
- ◆ Manual operation
- ◆ Adjustable running time
- ◆ Remote log on/off
- ◆ Wind travel direction
- ◆ Rain travel direction
- ◆ Software version

Further important information

- ◆ Saved settings are retained even in the event of a power failure. All settings are active again after reconnection of the power supply.
- ◆ If it starts to rain, it can take some time before the Smart weather sensor detects rain, depending on the intensity of the rain and the outdoor temperature.

Radio code

You can connect the Smart weather sensor to the DuoFern network using the radio code. The radio code is located on the bottom side of the Smart weather sensor **and** on a label attached to the packaging.

Time window for activation via the radio code

After switching on the power supply, the radio code is active for a maximum of 2 hours. Once this time has elapsed, activation using the radio code is no longer possible. Briefly disconnect the Smart weather sensor from the mains to reactivate the time window.

Connection and control possibilities

An awning or Venetian blind drive can be connected to the tubular motor actuator. If several awnings or Venetian blinds are to be controlled together, connection via an additional multiple control relay is possible.



Installation as a stationary controller

The Smart weather sensor may only be used as a stationary installation, i.e. only in an installed state and after completion of all installation and commissioning operations and only in the intended environment.



Risk of short-circuits when installing in the rain

Do not open the Smart weather sensor if water (rain) can penetrate into it; even a few drops could damage the electronics. Ensure it is connected properly. An incorrect connection can lead to destruction of the Smart weather sensor and the control electronics.



Avoid damage during the installation

During installation, pay particular attention to ensure that the temperature sensor (small printed circuit board on the underside of the housing) is not damaged. Also ensure the connecting cable between the printed circuit board and rain sensor is not torn off or kinked when connecting it.

Notes on radio systems

During planning, ensure that there is adequate radio reception. The range of radio controls is limited by the statutory provisions for radio systems and by conditions at the installation site (if the radio signal has to pass through walls and ceilings).

A minimum distance of 30 cm should be maintained between radio transmitters in order not to impair the reception quality. Powerful local transmitters (e.g. radio headphones) transmitting in the same frequency band can interfere with the reception.

Dimensions and drilling templates

All the dimensioned drawings necessary for the installation can be found on page 47.



Location / Minimum height

The Smart weather sensor must be installed at a minimum height of 2 metres.

Select an installation position on the building where wind, rain and sun can be detected by the sensors without any impeding structures. No structural parts may be installed above the Smart weather sensor from which water can drip onto the precipitation sensor after it has already stopped raining or snowing. The building or, for example, trees must not cast shadows onto the Smart weather sensor. A distance of at least 60 cm must be allowed under the Smart weather sensor to permit proper wind measurement and to prevent it being covered by snow.

The Smart weather sensor must be installed on a vertical wall (or mast) and aligned horizontally in the transverse direction.

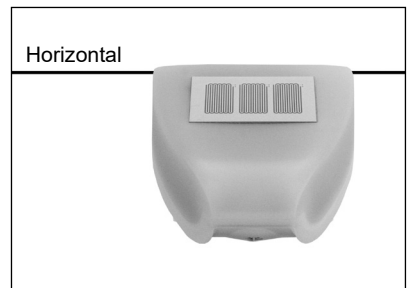
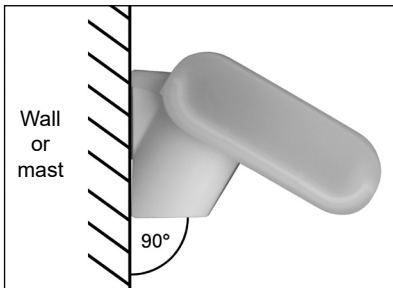

Fitting the bracket

The Smart weather sensor includes a combined wall/mast bracket. Upon delivery, the bracket is fastened to the rear of the housing with adhesive tape.

Fasten the bracket perpendicularly to the wall or mast.

Wall installation:

Flat side towards the wall, semi-circular rib facing upwards.

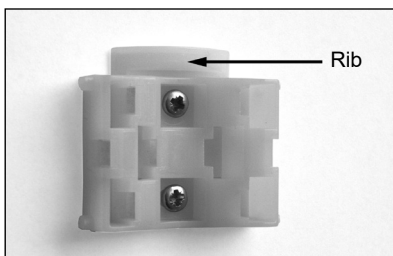

Mast installation:

Curved side towards the mast, rib facing downwards.

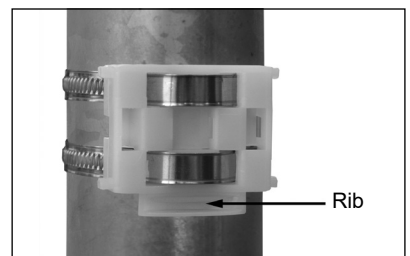



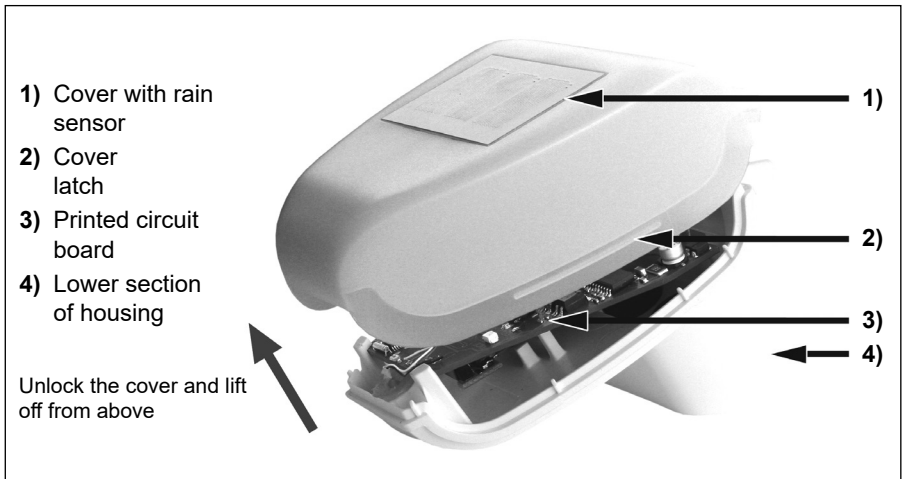

Preparation of the Smart weather sensor

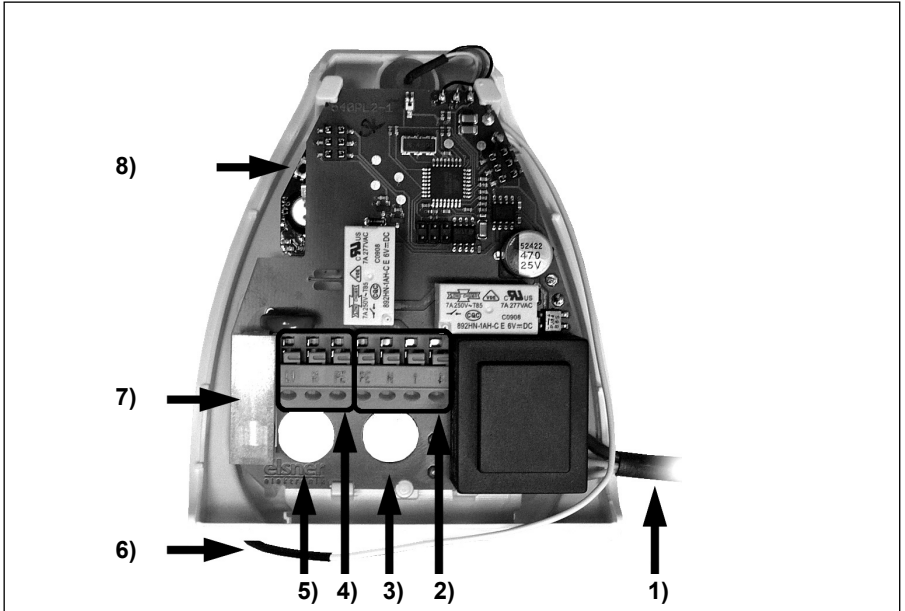

The cover of the Smart weather sensor with the rain sensor is latched at the lower edge on the left and right (see Fig.). Remove the cover from the Smart weather sensor. Proceed carefully to avoid tearing off the cable connection between the printed circuit board in the lower section and the rain sensor in the cover.



Legend

- 1) Cable connection to the rain sensor in the housing cover
- 2) Drive connections (spring-loaded terminal,  / N / Up / Down), suitable for solid conductor up to 1.5 mm² or fine-wire conductor
- 3) Opening for a motor cable
- 4) Power supply connections (230 V/50 Hz, spring-loaded terminal, L1 / N / )
suitable for solid conductor up to 1.5 mm² or fine-wire conductor
- 5) Opening for the power supply connecting cable
- 6) Antenna
- 7) Fine fuse 6.3 A
- 8) Reset button



ATTENTION!



When connecting the cable, the printed circuit board must not be removed from the bracket.

**There is a risk of fatal electric shock when touching electrical components.**

- ◆ The electrical connection and all work on electrical systems must only be carried out by a qualified electrician in accordance with the connection instructions in this manual.
- ◆ Carry out all installation and connection work only in a de-energised state.
- ◆ Disconnect all phases of the mains power lead and secure it to prevent any reconnection.
- ◆ Check that the system is de-energised.
- ◆ Prior to connecting, compare the information about voltage/frequency on the device with that of the local electrical grid operator.

**Incorrect wiring may lead to short circuits and destroy the device.**

- ◆ Observe the sequence of connector pin assignments in the wiring diagram on page 14.



Follow all the electrical connection specifications in the operating manuals of your tubular motor.

**A defective antenna can cause malfunctions or the failure of the Smart weather sensor.**

- ◆ The antenna lead must not be shortened and damaged.

Information for the parallel connection of several drives**The parallel connection of unsuitable motors can result in damage. Therefore strictly observe the specifications in the operating manuals of the respective tubular motors.**

- ◆ The drive of the awning or Venetian blind is connected to the Smart weather sensor. Several drives can be connected in parallel. When connecting motors in parallel, check whether a multiple control relay is prescribed by the motor manufacturer.
- ◆ Motors with a power consumption higher than 1000 watts must be operated via a relay or contactor with a separate mains supply lead.



Wiring diagram for the connection of tubular motors.



Before connection, please read the operating manuals for the relevant tubular motor.

ATTENTION!

When connecting HOMEPILOT tubular motors with mechanical end point settings, or the tubular motors of other manufacturers, a circuit bridge on the printed circuit board of the Smart weather sensor must first be removed, otherwise damage may occur to the Smart weather sensor and drive.

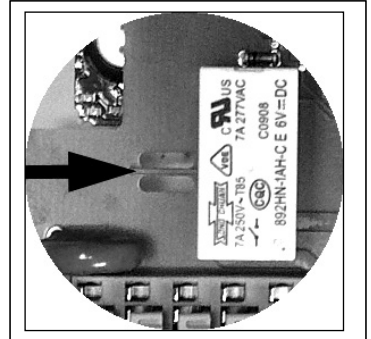

Use of the setting wire for electronic HOMEPILOT tubular motors:

After connection of an electronic HOMEPILOT tubular motor, the setting wire must be connected to the neutral conductor (N) without fail.

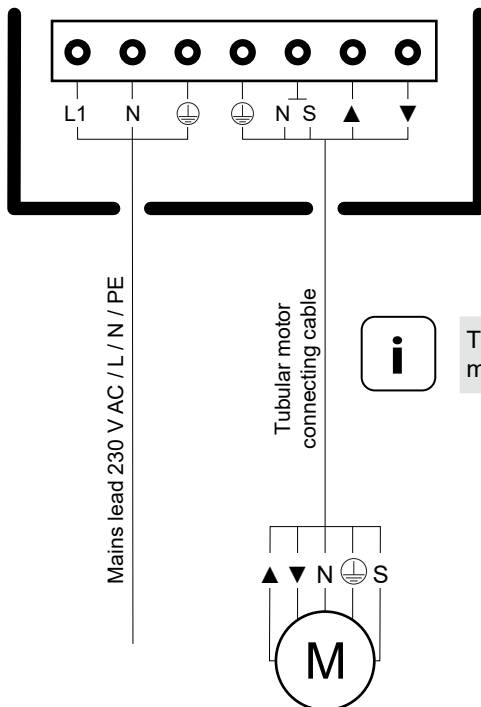

The earthing must also be connected when connecting an appliance.





The connecting cable of the tubular motor may not exceed 3 m.

- ▲ = Up
- ▼ = Down
- N = Neutral conductor
- ⊕ = Earth
- S = Setting wire (if available)
- M = Motor



Connection of the power supply and drive

1. Insert the cables for the power supply and drive through the rubber seals on the underside of the Smart weather sensor and connect the power supply (L1 / N / ) and the drive ( / N / Up / Down) to the corresponding terminals.
2. Close the housing by pressing the cover onto the lower section. The cover must engage on the left and right with an audible “click”.
3. Check that the cover and lower section are correctly engaged! The figure shows the closed weather station from below.



Damaged connecting cables may result in danger to life due to a short-circuit.

Avoid clamping all the connecting cables or the antenna.

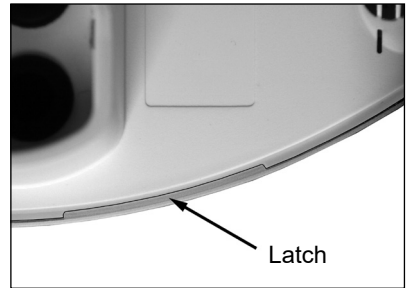

Final installation of the Smart weather sensor



Push the housing into the installed bracket from above. The tabs on the bracket must engage in the rails of the housing.

The weather station can be removed from the bracket again by pulling up against the resistance of the latches.

After wiring up the system and checking all connections, proceed as follows:

1. Switch on the mains voltage of the Smart weather sensor.
2. Open the HOMEPILOT app.
3. Connect the Smart weather sensor with your Premium gateway using the radio code.

i Important information for service personnel and fitters

If necessary, the Smart weather sensor can be reset to the factory settings, see page 41.



Resetting the Smart weather sensor to the factory settings

EN

Important information for service personnel and fitters

If necessary, the Smart weather sensor can be reset to the factory settings. To do this, the housing cover of the Smart weather sensor must be carefully opened with the sensor in use. The position of the set button can be seen in the figure.

 **DANGER!**



Risk of fatal injury when coming into contact with live electrical components.

- ◆ This work should only be carried out by trained service personnel or an electrician.
- ◆ This action is carried out in a closed condition with a 230 V / 50 Hz mains supply applied.
- ◆ Therefore use an insulated electrical tool to press the reset button.

1. Press the set button for 5 seconds, then all settings in the Smart weather sensor are deleted and reset to the factory settings.



Only press the reset button with an insulated tool.

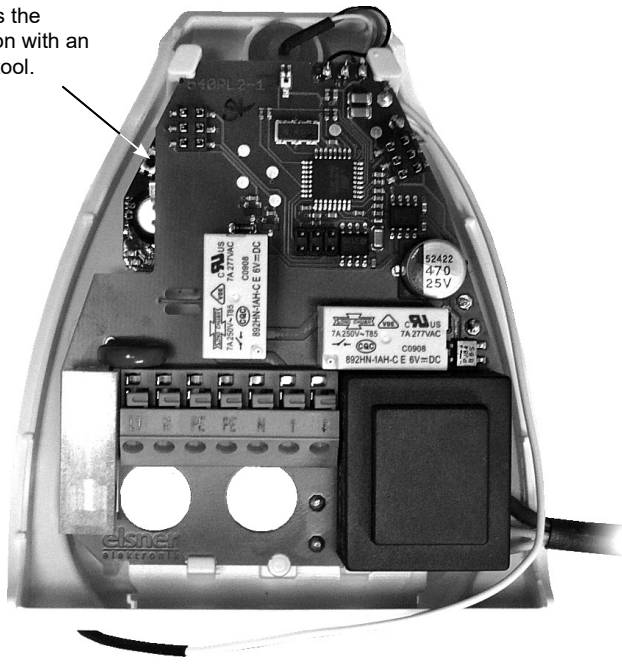



The Smart weather sensor should be inspected for soiling twice a year and cleaned as necessary. In the event of heavy soiling, the wind sensor may cease to function, display a constant rain alarm or no longer detect sunshine.

In the event of a power failure, the data input by you is stored for approx. 10 years. No battery is necessary for this.



The Smart weather sensor must always be disconnected from the mains power supply (e.g. switch off or remove fuse) for cleaning and maintenance.

Do not use any abrasive or corrosive cleaning agents

Use a soft cloth to remove dirt flecks. In case of stubborn soiling, use a cloth dampened slightly with water or a neutral cleaning solution. Finally wipe off with a soft dry cloth.



Insecticides / solvents and similar substances can destroy the gilded contact surfaces of the Smart weather sensor.

Avoid using these agents in the direct vicinity of the Smart weather sensor or protect the sensor surface against contact with these agents.



Technical specifications of the Smart weather sensor

EN

Operating voltage:	230 V / 50 Hz ~	
Ambient temperature:	-30 °C to +60 °C	
Protection class:	IP44	
Output:	loadable with max. 1000 W, fused with T 6.3 A micro fuse	
Dimensions:	approx. W = 96 mm, H = 77 mm, D = 118 mm	
Heating rain detector:	approx. 1.2 watts	
Temperature sensor measuring range:	-30 °C to +60 °C	
Temperature sensor resolution:	1°C	
Sun sensor measuring range:	1 to 150 kLux	
Sun sensor resolution:	1 kLux	
Twilight sensor measuring range:	0 to 100 Lux	
Twilight sensor resolution:	1 Lux	
Wind sensor measuring range:	0 m/s to 35 m/s	
Wind sensor resolution:	1 m/s	
Radio frequency:	434.5 MHz	
Transmission power:	max. 10 mW	
Range:	within a building:	approx. 30 m *
	outdoors:	approx. 100 m
	<i>* Depending on the building structure</i>	
Number of limiting value groups:	5	



Max. number of devices: 44



Simplified EU declaration of conformity

DELTA DORE RADEMACHER GmbH, hereby declares that the Smart weather sensor complies with the Directive **2014/53/EU (Radio Equipment Directive)**.

The full text of the EU declaration of conformity is available at the following website:

www.homepilot-smarthome.com



Information on the warranty condition is enclosed with the product.

Factory settings of the Smart weather sensor

DCF clock:	OFF
Active limiting value group:	A
Solar function active *:	Yes
Solar limit value:	31 kLux
Sun detection after:	10 minutes
Shade detection after:	20 minutes
Solar direction function active:	No
Link sun to temperature:	No
From a temperature of:	10 °C
Dawn function active *:	Yes
Dawn limit value:	60 Lux
Dusk function active *:	Yes
Dusk limit value:	15 Lux
Wind function active:	No
Wind, set limit:	12 m/s (43.2 km/h)
Rain function active:	No
Temperature function active:	No
Temperature, limit value:	-10 °C

* Limit values 2- 5 are deactivated at the factory



Manual operation:	OFF
Automatic timer:	OFF
Automatic solar function:	OFF
Automatic dawn function:	OFF
Automatic dusk function:	OFF
Automatic rain function:	OFF
Automatic wind function:	OFF
Running time:	150 seconds
Sunshine position active:	100 %
Ventilation position active	No
Ventilation position:	80 %
Standard travel direction wind:	Up
Standard travel direction rain:	Up
Rotation direction:	OFF

All dimensions in mm, technical deviations possible.

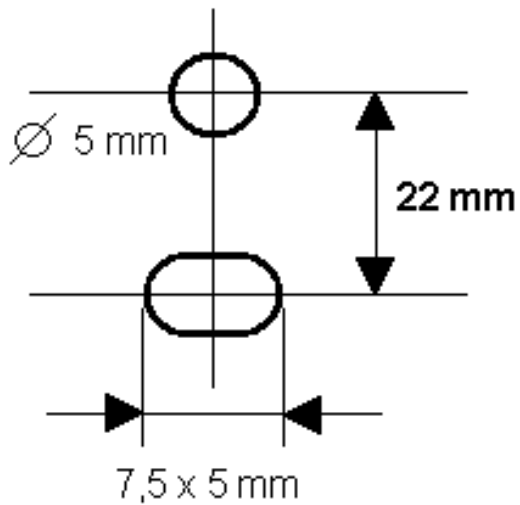
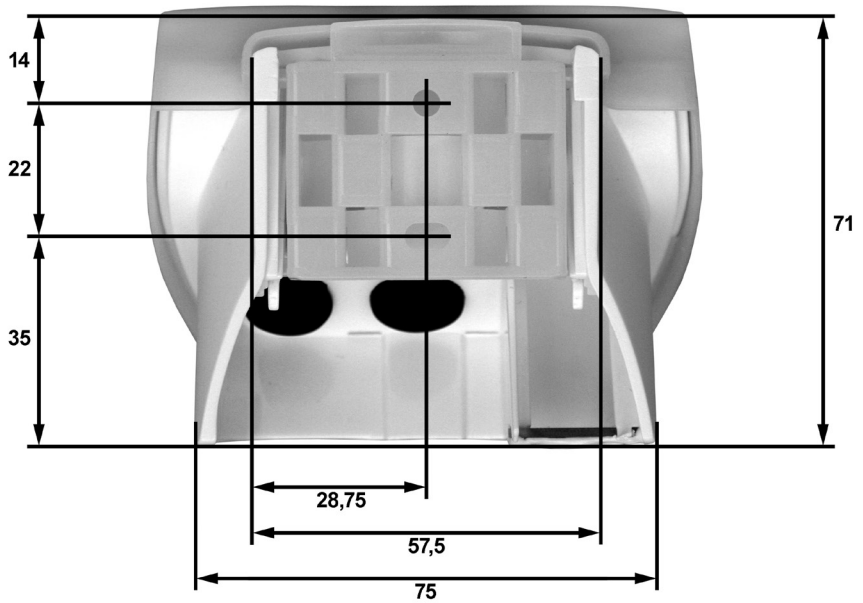

DELTA DORE
RADEMACHER GmbH
Buschkamp 7
46414 Rhede (Germany)

Subject to technical modifications, misprints and errors excepted. Illustrations not binding.