

EN Programmable timer lite premium
Instruction manual for the electrical connection and for commissioning

Item no. 10501002



| | | |
|-----|--|----|
| 1. | This manual | 4 |
| 1.1 | How to use this manual | 4 |
| 2. | Hazard symbols | 5 |
| 2.1 | Levels of danger and signal words..... | 5 |
| 2.2 | Symbols and depictions used..... | 6 |
| 3. | Safety instructions | 7 |
| 3.1 | Intended use..... | 8 |
| 3.2 | Improper use | 8 |
| 3.3 | Expert knowledge required by the installer..... | 8 |
| 4. | Included in delivery | 9 |
| 5. | General view of the operating unit | 10 |
| 5.1 | General view of the installation housing..... | 12 |
| 5.2 | Electrical connections | 13 |
| 5.3 | Display and its symbols | 14 |
| 6. | Product description | 15 |
| 6.1 | Description of the safety functions | 16 |
| 6.2 | Overview of functions..... | 16 |
| 7. | Technical specifications | 18 |
| 7.1 | Werkseinstellungen..... | 20 |
| 7.2 | Conduct in the event of a power failure | 21 |
| 8. | Safety instructions for the electrical connection | 22 |
| 8.1 | Important information prior to the electrical connection and installation | 24 |
| 8.2 | Electrical connection | 25 |
| 9. | Installation after the electrical connection | 27 |
| 10. | Brief description of the standard display and main menu | 28 |
| 11. | Introduction to opening the menus and setting the functions | 29 |
| 12. | Initial commissioning with the help of the installation wizard | 31 |

| | | |
|------|--|----|
| 13. | Manual operation | 33 |
| 14. | Memory function - accepting the current time as switching time | 34 |
| 15. | Menu overview | 35 |
| 16. | Menu 1 - Switching automatic mode on/off | 36 |
| 17. | Switching times (opening and closing times) [▲/▼], brief description..... | 37 |
| 17.1 | Menu 2 - Configuring opening and closing times [▲/▼] .. | 38 |
| 18. | Menu 6 - Configuring the random function | 40 |
| 19. | Menu 9 - System settings..... | 41 |
| 19.1 | Menu 9.1 - Setting the time and date | 42 |
| 19.2 | Menu 9.5 - Configuring the switching time programme ... | 43 |
| 19.3 | Menu 9.6 - Configuring the blockage detection..... | 44 |
| 20. | Menu 9.8 - Device settings | 47 |
| 20.1 | Menu 9.8.1 - Switching the automatic summer/winter time on/off | 48 |
| 20.2 | Menu 9.8.2 - Setting the display contrast..... | 49 |
| 20.3 | Menu 9.8.4 - Setting the timer mode | 49 |
| 20.4 | Menu 9.8.5 - Switching the button lock on / off..... | 50 |
| 20.5 | Menu 9.8.7- Switching the reversal of rotation direction on/off..... | 51 |
| 20.6 | Menu 9.8.0 - Displaying the software version..... | 52 |
| 21. | Deleting all settings, software reset..... | 53 |
| 22. | Performing a hardware reset | 54 |
| 23. | Error messages | 55 |
| 24. | Dismantling..... | 55 |
| 25. | Simplified EU declaration of conformity..... | 56 |



1. This manual...

EN

...describes how to install, connect the electrical system and operate the Programmable timer lite premium.



1.1 How to use this manual

- ◆ Before you begin, please read this manual through completely and follow all the safety instructions.
- ◆ Please also read the instruction manuals for the accessories (if available) as well as the manuals for the respective connected electrical appliances.
- ◆ This manual is part of the product. Please store it in an easily accessible place.
- ◆ When passing the Programmable timer lite premium on to a third party, this manual must be passed on as well.
- ◆ Damage resulting from non-compliance with this manual and the safety instructions will void the warranty. We assume no liability for any resulting damage.



2. Hazard symbols

EN

The following hazard symbols are used in this manual:



Danger of fatal electric shock



Danger area / dangerous situation



2.1 Levels of danger and signal words

 **DANGER!**

This hazard will lead to serious injury or death if not avoided.

 **WARNING!**

This hazard may result in serious injury or death if not avoided.

 **CAUTION!**

This hazard may result in minor or moderate injury if not avoided.

 **ATTENTION!**

This hazard may lead to property damage.



Other useful information



Please read the respective manual

1. Procedures

2.

◆ Itemisation

1) or a) Lists



Activated menu symbols and setting parameters flash on the display.

Information about opening the menus and setting the parameters can be found on page 29.





There is a risk of fatal electric shock when touching electrical components.

- ◆ The electrical connection and all work on electrical systems must only be carried out by a qualified electrician in accordance with the connection instructions in these operating instructions.
 - ◆ All connection and installation work must only be carried out in a de-energised state.
-



The use of defective devices can lead to personal injury and damage to property (electric shocks / short circuiting).

- ◆ Never use defective or damaged devices.
 - ◆ Check the Programmable timer lite premium for damage.
 - ◆ Please contact our Customer Service if you find any damage.
-



Improper use leads to an increased risk of injury.

- ◆ Train all personnel to use the Programmable timer lite premium safely.
- ◆ This device may be used by children from 8 years of age upwards as well as by persons with reduced physical, sensory or mental capacities or with lack of experience and knowledge if they are supervised or have been instructed on how to use the device safely and if they understand what dangers may result from this.
- ◆ Children must not play with the device.
- ◆ Never remove the operating unit from the installation housing during operation.

Use the Programmable timer lite premium only for connecting and controlling a tubular motor for roller shutters, Venetian blinds, slats or awnings.

Operating conditions

- ◆ The tubular motor must be fitted with a mechanical or electronic end position switch.
- ◆ Only operate the Programmable timer lite premium in dry rooms.
- ◆ A 230 V/50 Hz power supply, together with a site-provided disconnecting device (fuse), must be available at the installation location.

3.2 Improper use

Using the Programmable timer lite premium for purposes other than those previously mentioned is impermissible.



There is a risk to life caused through short circuiting and electric shocks if the Programmable timer lite premium is used outside or in damp rooms.

Do not install and use the Programmable timer lite premium outdoors or in damp rooms.

3.3 Expert knowledge required by the installer

The electrical connection, installation and commissioning of the Programmable timer lite premium must only be carried out by a qualified electrician in accordance with the instructions in this manual.

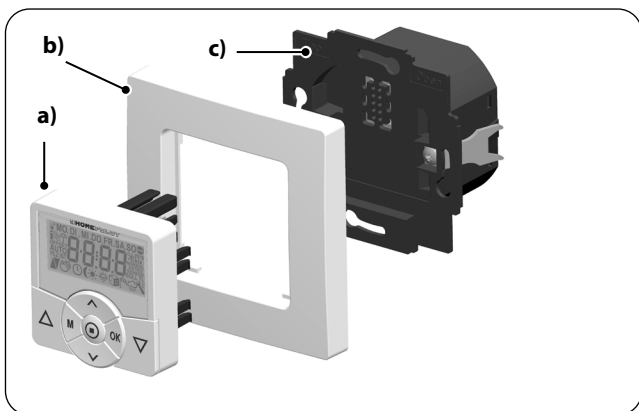





Included in delivery



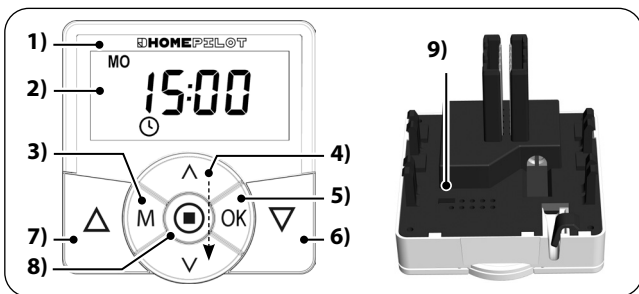

- a) 1 x Operating unit (50 x 50 mm)
- b) 1 x Frame
- c) 1 x Installation housing
- d) 1 x Instruction manual (not illustrated)

After unpacking please check and compare ...

... the contents of the package with those specified above.



| Pos. | Symbol | Description |
|------|---|---|
| 1) | | Operating unit |
| 2) | | Display |
| 3) |  | Menu button <ul style="list-style-type: none"> ◆ <i>Open the main menu</i> ◆ <i>Back to the previous menu or standard display</i> |
| 4) |   | Setting buttons <ul style="list-style-type: none"> ◆ <i>Select a menu in the main menu</i> ◆ <i>Set the parameters (more / less)</i> <ul style="list-style-type: none"> ● <i>Short press or press and hold = gradual or quick setting</i> ◆ <i>Switch functions on / off (On / OFF)</i> |

| Pos. | Symbol | Description |
|------|---|---|
| 5) |  | OK button <ul style="list-style-type: none">◆ <i>Open the selected menu</i>◆ <i>Confirm and save settings</i>◆ <i>Continue to the next setting</i> |
| 6) |  | Operating buttons Up / Down <ul style="list-style-type: none">◆ <i>Manual operation</i> |
| 7) |  | |
| 8) |  | SET/Stop button <ul style="list-style-type: none">◆ <i>Manual stop of the roller shutter travel</i>◆ <i>Set (adjust) various functions</i> |
| 9) | | Bridging contact for a hardware reset <ul style="list-style-type: none">◆ <i>See page 54</i> |

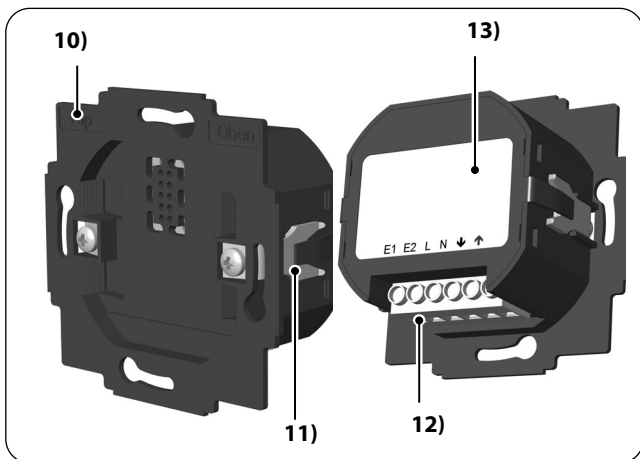

| Pos. | Symbol | Description |
|------|--------|---------------------------|
| 10) | | Installation housing |
| 11) | | Claw fasteners and screws |
| 12) | | Connecting terminals |
| 13) | | Type plate |

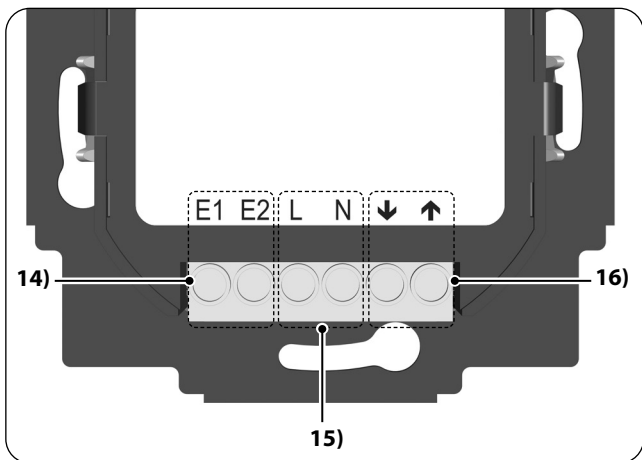

| Pos. | Symbol | Description |
|------|---------|--|
| 14) | E1 / E2 | External inputs - optional <i>Connect external signal transmitters or external controllers (e.g. Programmable timer premium), see page 26.</i> |
| 15) | L / N | Power supply - 230 V / 50 Hz ~ <i>Connect the supply voltage.</i> |
| 16) | ↓ / ↑ | Rotation direction (up / down) <i>Connecting cables to the tubular motor.</i> |

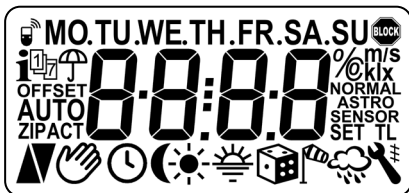

| Symbol | Description |
|------------------|-------------------------------|
| MO ... SU | Weekdays (Monday ... Sunday) |
| 88:88 | Time / setting parameters |
| i | Information |
| | Switching time programme |
| SET | Setting |
| AUTO | Automatic mode |
| ACT | Actual value |
| | Direction of travel (up/down) |
| | Automatic mode off |
| | Switching times |
| | Random function |
| | System settings |
| | Blockage detection |
| | Automatic button lock |

The Programmable timer lite premium controller is designed for controlling roller shutters, Venetian blinds, slats or awnings by connecting a corresponding tubular motor.

Roller shutter control

The device enables the roller shutter to be automated.

Manual operation

It is possible to manually control the connected tubular motor at any time by using the controls.

External control via two inputs E1 and E2

The Programmable timer lite premium features two inputs **E1** and **E2** (230 V / 50 Hz) for connecting external signal transmitters or external controllers (e. g. Programmable timer premium), see page 26.

Installation and electrical connection

The Programmable timer lite premium is designed as a flush-mounted device for indoor rooms. The electrical connection is carried out by means of the connecting terminals on the reverse side of the installation housing.

Installation / compatible switch ranges

The Programmable timer lite premium can be integrated into standard switch ranges (50 x 50 mm).



It may be necessary to use an intermediate frame *50x50 (according to DIN 49075) depending on the switch range used.

** Not included*

Blockage detection

The Programmable timer lite premium is able to monitor the torque of motors equipped with a mechanical end point setting. This enables the controller to switch off the motor in the event of overloading or blockage, see page 44.

6.2 Overview of functions

- ◆ Installation wizard for easy commissioning
- ◆ Configurable blockage detection for mechanical tubular motors
- ◆ Manual operation on site
- ◆ Switch automatic mode on/off
- ◆ Easy configuration with menu-driven operation
- ◆ Switching times
 - Configurable opening [▲] and closing times [▼] for your roller shutter
- ◆ Switching time programme:
 - Weekly switching times
 - One switching time pair [▲/▼] for [**MO...SU**] (MON...SUN)
 - Weekday and weekend switching times
 - One switching time pair [▲/▼] for [**MO...FR**] (MON...FRI)
 - One switching time pair [▲/▼] for [**SA + SU**] (SAT + SUN)
- ◆ Random function (random delay of 0 to 30 minutes)
- ◆ Button lock

- ◆ Memory function (easy acceptance of the current time as switching time)
- ◆ Switch reversal of rotation direction on/off
- ◆ Automatic summer / winter changeover
- ◆ Permanent storage of the settings
- ◆ External control via the two inputs E1 / E2
- ◆ Delete or reset all data

Description and configuration of the individual functions

A precise description of the individual functions and settings is included starting on page 28.



7. Technical specifications

EN

Mains supply [L / N]

| | |
|-----------------------|------------------|
| Mains supply voltage: | 230 V / 50 Hz ~ |
| Consumption: | Standby: < 0.6 W |

2 x extension inputs [E1 / E2]

connection of external signal transducers/external controllers

| | |
|-----------------------|-------------------------------|
| Input voltage: | 230 V / 50 Hz ~ (Ri = 200 kΩ) |
| Maximum cable length: | 15 metres |

Rotation direction [▲ / ▼]

| | |
|-----------------------------|---|
| Switching voltage: | 230 V / 50 Hz ~ |
| Maximum switching capacity: |  8 (4) A μ (Type 1B) |



Improper use can lead to serious injuries or property damage.

- ◆ Due to the small contact distance (μ), not suitable for disconnecting.
- ◆ The Programmable timer lite premium is not suitable to be used for an electrically safe disconnection of the connected appliance

| General information | |
|--|---|
| External dimensions (W x H x D) Operating unit [1]: | 50 x 50 x 12 mm according to DIN 49075 |
| Available colours: | Ultra-white (UW), Aluminium (AL) |
| Installation depth: | 32 mm |
| Permissible ambient temperature range: | 0 °C to + 40 °C |
| Protection class: | II (<i>only for use in dry rooms</i>) |
| Connecting terminals: | Screw terminals for max. 1.5 mm ² cable cross-section |
| Power reserve for the timer in the event of a power failure | approx. 8 hours |

| Factory settings | |
|--|-------------------|
| Automatic mode: | On |
| Switching times: | On |
| Date: | 01.07.2018 |
| Time: | 12:00 |
| Up-time and mode: | 7:00 |
| Down-time and mode: | 20:00 |
| Random function: | OFF |
| Switching time programme: | 1 |
| Blockage detection: | OFF |
| - Motor type: | 2 (45 mm / 30 Nm) |
| - Sensitivity: | 2:30 |
| - Reversing function: | OFF |
| Automatic summer / winter changeover: | On |
| Display contrast: | 8 |
| Timer mode: | 1 (50 Hz) |
| Button lock: | OFF |
| Reversal of direction of rotation: | OFF |

Power reserve (approx. 8 hours)

The current time flashes for approx. 5 minutes in the event of a power failure and the Programmable timer lite premium changes to power reserve.

Time and date after a power failure

The power reserve is approx. 8 hours. If this time is exceeded, the time and date are lost and need to be reset, see page 81.



The internal timer works with tolerances in power reserve mode. It may therefore be necessary to adjust the time after a longer power failure.

Data retention following a power failure

All settings remain permanently saved. Data is not lost even after a longer power failure..

Prior to the electrical connection, check that the voltage / frequency on the type plate corresponds to that of the local mains supply.



Follow the electrical connection specifications in the instruction manual of the tubular motor being used or the external controller (when using E1/E2).

DANGER!

There is a risk of fatal electric shock when touching electrical components.

- ◆ All connection and installation work must only be carried out in a de-energised state.
- ◆ Disconnect all phases of the mains power cable and secure it to prevent any reconnection.
- ◆ Check that the system is de-energised.

WARNING!

Overloading of the Programmable timer lite premium can lead to personal injury and destruction of the device (short circuiting).

The maximum switching capacity must not be exceeded; please observe the details in the technical specifications, see page 18.

 **WARNING!**

Using an incorrect installation housing can lead to personal injury and damage to property (electric shocks / short circuiting).

- ◆ Only use the installation housing provided to connect and install the Programmable timer lite premium.
- ◆ Installation housings of other HOMEPILOT products, such as other Troll programmable timers, are not compatible.

 **WARNING!**

Connection of a second phase to E1 or E2 will cause the Programmable timer lite premium to be damaged.

- ◆ When using the inputs [E1 / E2], they must always be connected to the same phase [L] as the supply voltage.
- ◆ If another phase is connected, the incorrect mains voltage (380 V / 50 Hz) will be applied to the inputs and damage the Programmable timer lite premium.
- ◆ Follow the pin assignment detailed in the connection diagram.

Setting the end points on the tubular motor



You must configure the end points of the tubular motor before installing it and making the final electrical connection otherwise malfunctions may occur.

It is essential that you set both end points of the tubular motor if no end points have been set yet.

Parallel connection of electronic tubular motors

A maximum of 3 tubular motors can be connected in parallel to the Programmable timer lite premium (e.g. HOMEPILOT electronic tubular motors).



In order to do so, follow the information in the instruction manual of the tubular motor being used..

Parallel connection of mechanical tubular motors

A cut-off relay is required in order to connect mechanical tubular motors in parallel.

Requirements for blockage detection

Blockage detection is only operational if a mechanical tubular motor is connected.

Function of inputs E1 and E2

E1 = UP

E2 = DOWN



The external signals to inputs E1 and E2 are only taken into consideration when the automatic mode is activated.

Maximum cable length for connecting external signal transducers to E1 or E2

The maximum cable length for connecting external signal transducers to E1 or E2 must be 15 metres.

Installation materials

The Programmable timer lite premium is designed for flush-mounted installation. We recommend installation in a deep 58 mm flush-mounted box or in an electronic socket.

Stripping length



All leads must be stripped to 6 mm.

8.2 Electrical connection

1. Ensure the mains is disconnected and check whether the mains power cables are current-free.
2. Securely lay all connecting cables right into the flush-mounted box.
3. Remove the insulation on all leads down to 6 mm in length and connect them according to the connection diagram on the following pages.
4. After the electrical connection, the installation of the Programmable timer lite premium into the flush-mounted box is carried out, see page 27.

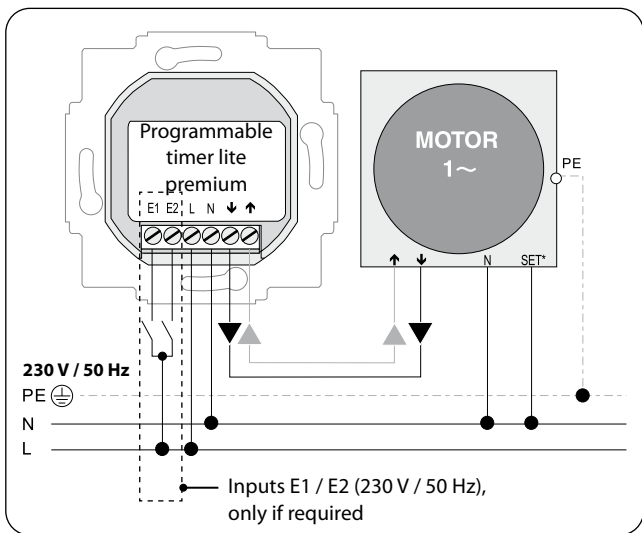

Connecting the white set lead (SET) from HOMEPILOT tubular motors

- * The white set lead (**SET**) from HOMEPILOT tubular motors must be connected to the neutral terminal [**N**] to ensure trouble-free operation of the tubular motor..

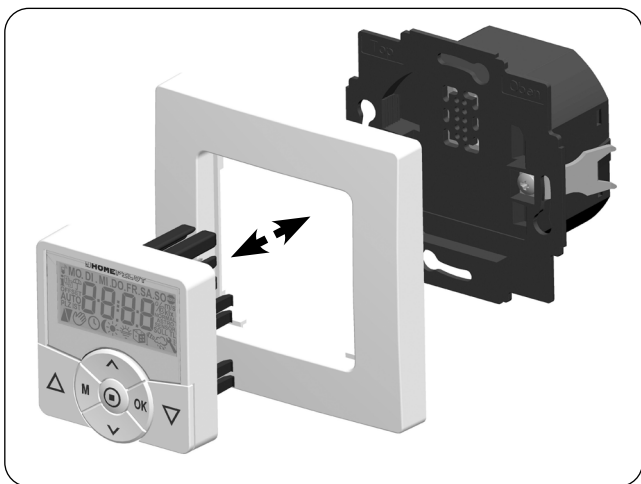

1. Insert the installation housing into the flush-mounted box and fasten it with the screws of the claw fasteners.
2. Place the frame onto the installation housing.
3. Then carefully insert the operating unit into the installation housing .
4. Switch on the mains power supply again..

The standard display (example)

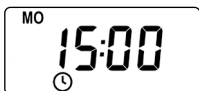

- ◆ Displays the current day of the week and time.
- ◆ Displays the activated functions.
- ◆ Manual operation of the Programmable timer lite premium is only possible from the standard display.

Main menu



Menu number

Functions / menus

- ◆ Enables display and selection of the individual functions and menus.
- ◆ Manual operation is not possible from the main menu.
- ◆ No automatic switching commands will be executed during the configuration process.
- ◆ If no button is pressed within approx. 120 seconds, the display automatically changes from the active menu back to the standard display. Changes to settings are nevertheless saved.



11. Introduction to opening the menus and setting the functions

EN

1. **M**

Open the main menu.



Pressing the menu button on the standard display opens the main menu.

2. **^** / **v**

Select the desired menu or menu number.

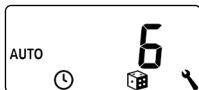

The selected menu is indicated by a flashing symbol.

3. **OK**

Confirm and open the selected menu.



OFF flashes.

4. **^** / **v**

Select the desired setting (e.g. On).



5. **OK**

Each setting must be confirmed with the OK button.

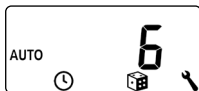

Confirming the entry takes you to the next setting or back to the menu.

6. **M**

Back to the standard display.

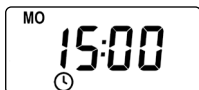

Example



Pressing the menu button briefly takes you back one menu step. Pressing and holding the button always take you to the standard display.

The installation wizard, which guides you through the first basic settings, is automatically started for the initial commissioning or after a software reset.

Quitting the installation wizard

Pressing the **M** button for one second causes the installation wizard to be cancelled prematurely.

Readiness for operation

The Programmable timer lite premium is ready for operation after completing the settings.

1. The installation wizard is shown after switching on the mains voltage. The digits start flashing.

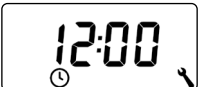
2.  Set and confirm the current time.

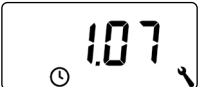
3.  Set the current date (day. month) and confirm each setting.

4.  Set and confirm the current year.

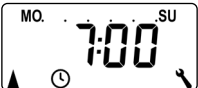
5.  Set and confirm the opening time [▲].
Pre-setting: MO...SU (MON...SUN) *

6.

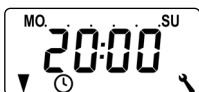

Set and confirm the closing time [▼].

Pre-setting: MO...SU (MON...SUN) *

* The opening time and the closing time applies to the entire week. If necessary, you can subsequently select one of two switching time programmes in menu **9.5**, see page 43.

7.

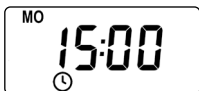

The standard display is shown after the final setting, see example.

The Programmable timer lite premium is now ready for operation.







13. Manual operation

Manual operation is possible from the standard display at any time and has priority over the programmed automatic functions.

Example for manual control of a roller shutter

-  Open the roller shutter.
Pressing the button briefly causes the roller shutter to move to the upper end point.

-  /  or  causes the roller shutter to stop in the interim.

-  Close the roller shutter.
The roller shutter moves to the lower end point.

The memory function enables you to easily adapt the switching times during the course of the year by allowing the current time to be accepted as the switching time, without having to access the switching time menu.



If weekday and weekend switching times are activated [**MO...FR** / **SA+SU**] the newly accepted switching time will only apply to the current group of days, e.g. for [**MO...FR**].



Accept the current time as the opening time [].*

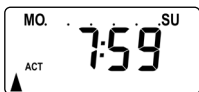

Example

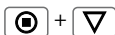

or

Accept the current time as the closing time [].*

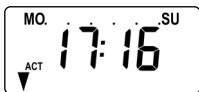









Example

* In order to do so, simultaneously press the respective keys.

The display flashes briefly by way of confirmation and the roller shutters move in the respective direction.

Main menu

| Symbol | Menu | Page |
|---|---|------|
| AUTO | 1 Automatic mode | 36 |
|  | 2 Switching times | 37 |
|  | 6 Random function | 40 |
|  | 9 System settings | 41 |
| SET | 9.1 Time and date | 42 |
|  | 9.5 Switching time programme | 43 |
|  | 9.6 Blockage detection | 44 |
|  | 9.8 Device settings | 47 |
| | 9.8.1 Automatic summer / winter changeover | 48 |
| | 9.8.2 Display contrast | 49 |
|  | 9.8.4 Timer mode | 49 |
| | 9.8.5 Button lock | 50 |
|  | 9.8.7 Reversal of rotation direction | 51 |
|  | 9.8.0 Software version | 52 |



Automatic mode on (symbol on the standard display)

- ◆ All set automatic functions are active
- ◆ Manual operation is also possible in automatic mode



Automatic mode off (symbol on the standard display)

- ◆ All automatic functions are deactivated
- ◆ All automatic symbols are deactivated on the standard display
- ◆ Inputs E1 and E2 will not be taken into consideration

Switching automatic mode on/off in menu 1

1.

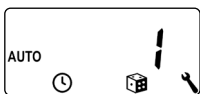

Open menu 1.

2.

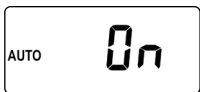

Set and confirm the desired setting.

OFF = automatic mode off

On = automatic mode on

Toggle directly on the standard display

OK 1 sec.

Press the OK button for one second on the standard display.



17. Switching times (opening and closing times) [▲/▼], brief description

EN

You can configure various **opening [▲] and closing times [▼]** for the Programmable timer lite premium in order to open or close your roller shutter automatically at your preferred times.

For this purpose, there are two switching time programmes available in menu 9.5, see page 43:

[1] Weekly switching times (factory setting)

The switching times [▲/▼] apply from **(MO SU)** (MON...SUN).

[2] Working day and weekend switching times

Separate switching times [▲/▼] for **(MO FR)** (MON...FRI) and **(SA + SU)** (SAT + SUN).



Alternatively, it is also possible to accept the current time as the switching time, see page 34 „Memory function“.



17.1 Menu 2 - Configuring opening and closing times [▲/▼]

EN

If the type of switching time programme (weekly switching times, working day / weekend switching times) is not to be changed, start directly with **point 2**.

1. If you want to change the type of switching time programme, first open menu **9.5**, see page 43 and configure the desired switching time programme.



- 2.

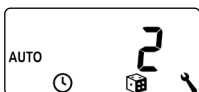

Open menu **2** if the desired switching time programme is already active.

The active switching programme is shown at the top of the display while you set the opening and closing times.

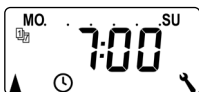

Weekly switching times



Weekday / weekend switching times



17.1 Menu 2 - Configuring opening and closing times [▲/▼]

EN

The following serves to describe the procedure for setting an **opening and closing time [▲/▼]** as **weekly switching times**.

3.

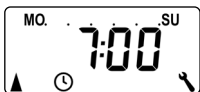

Set and confirm an **opening time [▲]**.

4.

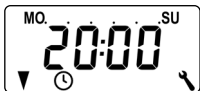

Set and confirm the **closing time [▼]**.

The opening and closing time applies to all days of the week [**MO SU**] (MON ... SUN).



18. Menu 6 - Configuring the random function

EN

The random function enables a random delay of the set timer periods ranging between 0 and 30 minutes.

The random function is executed for:

All automatic opening and closing times.

Please note the state of the cube symbol on the standard display



The cube symbol flashes on the standard display when the random function is activated during the period in which the movement command is being delayed.

1.

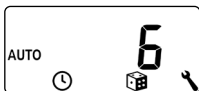

Open menu **6**.

2.



Select and confirm the desired setting.

On = random function on



Off = random function off

Subsequently the main menu will be displayed again.





This menu enables you to configure additional devices and system settings to customise your Programmable timer lite premium to your individual preferences.

Menu 9 - System settings

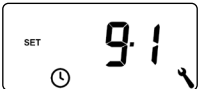
| Symbol | Menu | Page |
|---|------------------------------------|------|
| SET | 9.1 Time and date | 42 |
|  | 9.5 Switching time programme | 43 |
|  | 9.6 Blockage detection | 44 |
|  | 9.8 Device settings | 47 |

1.  Open menu **9.1**.
Configure and confirm the desired settings.

Setting order:

2.  Time
3.  Date
Day.Month
4.  Year
2000 to 2099

The number of opening and closing times that can be configured depends on the desired switching time programme selected in this menu.

There are two switching time programmes available:

[1] Weekly switching times (factory setting)

The switching times [▲/▼] apply from (MO SU) (MON...SUN).

[2] Working day and weekend switching times

Separate switching times [▲/▼] for (MO FR) (MON...FRI) and (SA + SU) (SAT + SUN).

1. Open menu **9.5**.

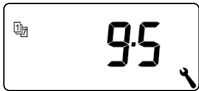

2. Select and confirm the desired week programme.

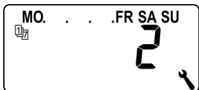
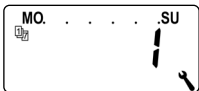

The switching times [▲/▼] are configured in menu **2**, see page 38.

The Programmable timer lite premium is able to monitor the torque of motors equipped with a mechanical end point setting. This enables the controller to switch off the motor in the event of overloading or blockage. As a result, the roller shutter is protected from damage.



Blockage detection can only be used in combination with a tubular motor **with mechanical end point setting**.

1.

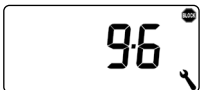

Open menu **9.6**.

2.

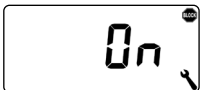

Activate/deactivate the blockage detection and confirm.

On = blockage detection on *

Off = blockage detection off **

* Continue with point 3.

** After deactivation and confirmation the display jumps back to the menu..

3.

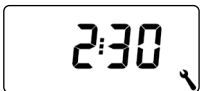

Select and confirm the suitable motor type.

A list of the motor types is provided on the following page.



Please also read the instruction manual for the tubular motor being used.

| Motor types | Ø | Power |
|-------------|-------|-----------|
| 1:06 | 35 mm | 6 Nm |
| 1:10 | 35 mm | bis 10 Nm |
| 2:10 | 45 mm | bis 10 Nm |
| 2:20 | 45 mm | bis 20 Nm |
| 2:30 | 45 mm | bis 30 Nm |
| 2:40 | 45 mm | bis 40 Nm |
| 2:50 | 45 mm | bis 50 Nm |

If the installed motor type is unknown, please select:

1:06 for roller shutters with an area of up to 1.5 m²

2:30 for larger roller shutters

4.

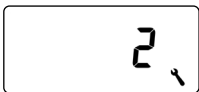

Set and confirm the sensitivity.

Sensitivity:

1 = low

6 = high



Test runs should be made to ascertain the highest possible sensitivity in order to protect the roller shutter in the event of blockage.



It may be necessary to customise the **cut-off sensitivity** depending on the properties of the roller shutter (weight, running characteristics etc.).

5.

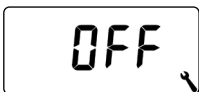

Activate/ deactivate the **reversing function** after a blockage is detected.

On = reversing function on

Off = reversing function off

Automatic reversing function in the event of a blockage

In the event of a blockage, the motor immediately runs in the opposite direction for approx. 2 seconds to release the roller shutter.

More information about the blockage detection:

- ◆ If longer connecting leads are used (>5 m), it is possible that the blockage detection system will fail to work correctly due to external interference.
- ◆ It is possible that the motor will be switched off by the blockage detection system when moving out of the end points when using mechanical motors with high switching hysteresis. Blockage detection must be deactivated for this type of motor.





Some motors can trigger undesired reversing when reaching the end positions (e.g. atypical internal motor wiring, long cables etc.). In such cases it is recommended to deactivate the reversing function.



If the motor type cannot be precisely determined, then a suitable setting for motor type and sensitivity must be determined by trial and error.



Menu 9.8 - Device Settings

| Symbol | Menu | Page |
|---|---|-------------|
| | 9.8.1 Automatic summer / winter changeover | 48 |
| | 9.8.2 Display contrast | 49 |
|  | 9.8.4 Timer mode | 49 |
| | 9.8.5 Button lock | 50 |
|  | 9.8.7 Reversal of rotation direction | 51 |
|  | 9.8.0 Software version | 52 |



20.1 Menu 9.8.1 - Switching the automatic summer/winter time on/off

EN

The Programmable timer lite premium features an automatic summer/winter changeover function.

Summer time

The timer is changed to summer time on the last Sunday in March. The timer is set back one hour at 02:00 hours.

Winter time

The timer is changed to winter time (standard time) on the last Sunday in October. The timer is set back one hour at 03:00 hours.

Recommendation for operating the device outside Germany

If the Programmable timer lite premium is not being used in Germany, it may be necessary to switch off the automatic summer/winter changeover function.

1.  Open menu **9.8.1**.

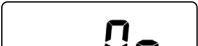
2.  Activate or deactivate the summer/winter changeover function and confirm.

On = function on

Off = function off



20.2 Menu 9.8.2 - Setting the display contrast

EN

1. Open menu **9.8.2**.

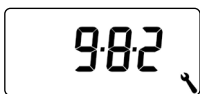

2. Set and confirm the desired contrast.



1 = low contrast
10 = high contrast



20.3 Menu 9.8.4 - Setting the timer mode

This menu enables you to configure the time base for the internal timer (depending on the local power supply).

1. Open menu **9.8.4**.

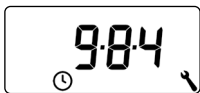

2. Set and confirm the desired timer mode.



1 = 50 Hz operation (factory setting)
e.g. in Europe

2 = 60 Hz operation
e.g. in the USA

3 = Quartz timer
for other mains frequencies



You can activate the automatic button lock to protect against any unintentional input.

1. Open menu **9.8.5**.

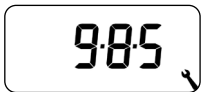

2. Activate/deactivate the button lock and confirm.

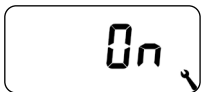

On = button lock on
Off = button lock off

Automatic activation after approx. two minutes

If the button lock is activated and no buttons are pressed within a period of two minutes, the button lock is switched on automatically.

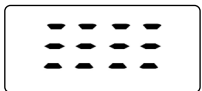

If an attempt is made to call up the menu when the button lock is active, the display flashes.

The button lock is deactivated manually on the standard display

-  4 sec. Press and hold for 4 seconds.

The button lock is activated manually on the standard display before the time limit expires

-  4 sec. Press and hold for 4 seconds if you want to activate the automatic button lock before the two minutes expire.



Manual operation of the Programmable timer lite premium is also possible when the button lock is active.



20.5 Menu 9.8.7 - Switching the reversal of rotation direction on/off

EN

It is not necessary to re-wire the motor if the direction of rotation of the connected motor is wrong ([**UP**] button moves the roller shutter downwards and [**Down**] button moves the roller shutter upwards). The direction of the motor can be easily changed using the **reversal of rotation** direction function.

1. Open menu **9.8.7**.

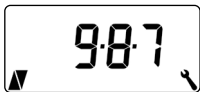

2. Activate or deactivate reversal of rotation direction..









On = reversal of rotation direction on
Off = reversal of rotation direction off

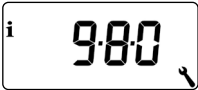

20.6 Menu 9.8.0 - Displaying the software version

EN

This menu enables the current Programmable timer lite premium software version to be displayed.

-  Open menu **9.8.0**.
-  The current software version is subsequently displayed.
- 
 Display the device version.
S = Programmable timer lite premium
- 
 Perform a display test.
-  Return to menu **9.8** - Device settings.

A software reset can be performed to reset the Programmable timer lite premium to the original default condition as when supplied.

1.  +  +  + 

Press and hold the four buttons simultaneously for 5 seconds until all the symbols are shown on the display.



2.  Then the device type (S = lite premium) and
ware version are displayed for five seconds.

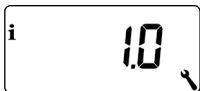

All settings are deleted and reset to the factory settings.

3. Start with the settings as specified from page 31 onwards (installation wizard).

A hardware reset can be performed in the event that the Programmable timer lite premium no longer react to commands.

1. To do so, pull the operating unit out of the installation housing.

2. The centre section on the rear of the operating unit contains an opening with two contacts that must be carefully bridged for a few seconds, for example, with the help of a flat-head screwdriver.

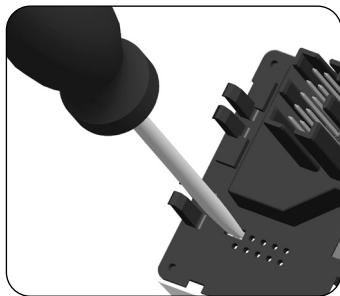

3. The operating unit can be returned to the installation housing as soon as the screwdriver has been removed from the contacts.

The time and date will be lost during a hardware reset. All other settings are retained.

Error 2 (display „E2“)

Internal device error highlighting that the Programmable timer lite premium may be defective.

- ◆ Please then contact HOMEPILOT Service.

24. Dismantling**DANGER!**

There is a risk of fatal electric shock when touching electrical components.

- ◆ Disconnect all phases of the mains power cable and secure it to prevent any reconnection. Check that the system is de-energised.

1. Switch off the mains power, secure it against restarting and check that the system is de-energised
2. Carefully pull the operating unit out of the installation housing.
3. Remove the frame.
4. Release the claw fasteners of the installation housing and pull it out of the flush-mounted box.
5. Disconnect the connecting cable from the installation housing.
6. Secure the connection point against restarting and the connecting cable from unintentional contact.



DELTA DORE RADEMACHER GmbH, hereby declares that the Programmable timer lite premium complies with the Directives **2014/35/EU (Low-voltage directive) and 2014/30/EU (EMC directive)**.

The full text of the declaration of conformity is available at the following website:

www.homepilot-smarthome.com

Warranty terms and conditions

Information on the warranty conditions is enclosed with the product.

DELTA DORE
RADEMACHER GmbH
Buschkamp 7
46414 Rhede (Germany)

Subject to technical modifications, misprints and errors excepted. Illustrations not binding.